

## 12 1/4" Diameter Shoes

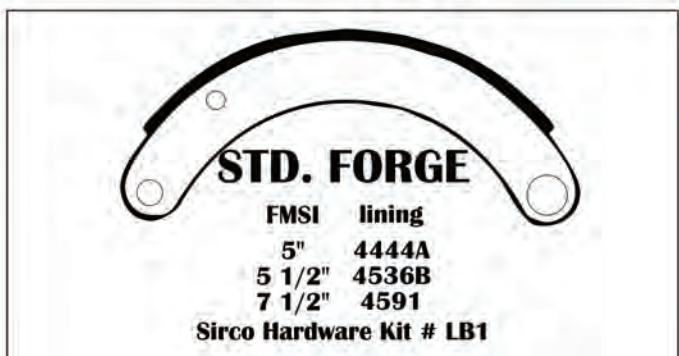

## 15" Single Web Shoes

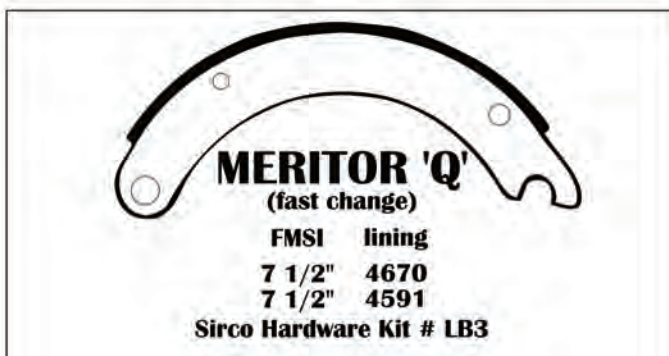
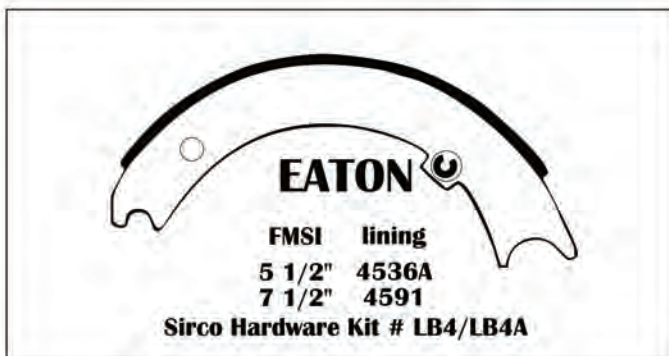
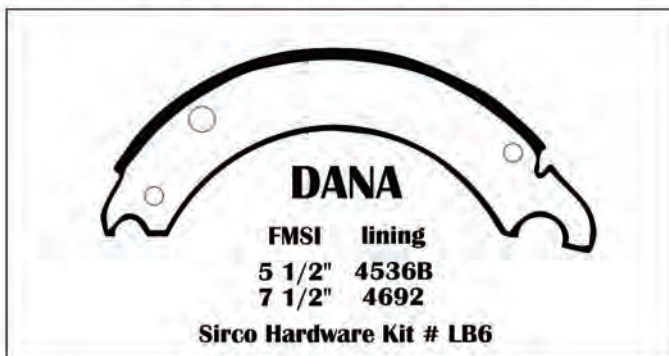
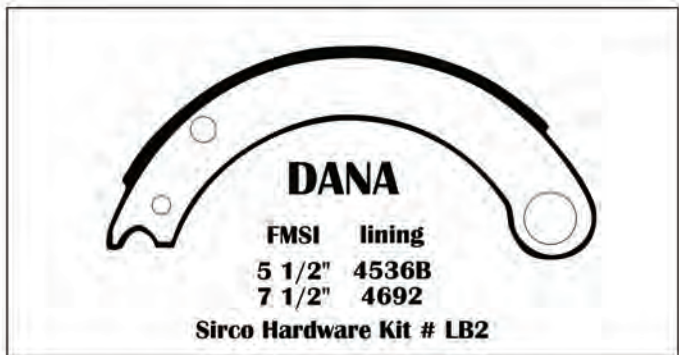
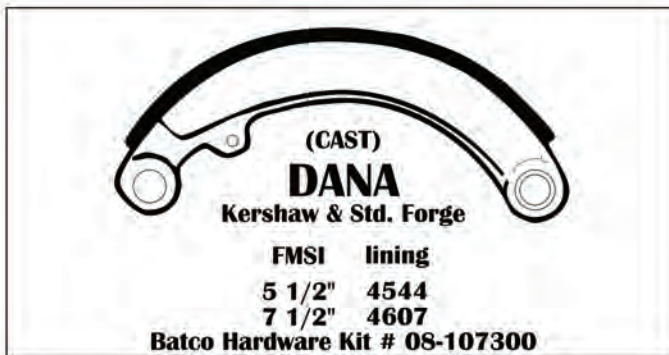

15" x 5"  
 FMSI LINING 1252



15" x 6"  
 FMSI LINING 4596



15" x 4"  
 FMSI LINING 1308A  
 The 458 is 2 15/32" wide at the Apex  
 of the rib and the 426 is 2 23/32".  
 The 458 will fit both applications  
 Sirco Hardware Kit # WF1



15" x 3"  
 FMSI LINING 1278  
 Batco Hardware Kit # 08-110200



15" x 7"  
 FMSI LINING 4597



15" x 3 1/2"  
 FMSI LINING 1280



15" x 3"  
 FMSI LINING 1245A



15" x 5"  
 FMSI LINING 4646

## 15" Single Web Shoes (cont.)

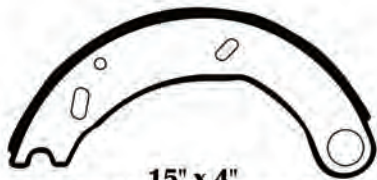

15" x 4"  
 FMSI LINING 1308A/512

Sirco Hardware Kit # WFI



15" x 3"  
 FMSI LINING 1245C



15" x 4"  
 FMSI LINING 4647



LUCAS/GIRLING  
 15" x 5"  
 FMSI LINING 4528A

Euclid Hardware Kit # E-7969



15" x 3 1/2"  
 FMSI LINING 1280B



15" x 4"  
 FMSI LINING 2032



LUCAS/GIRLING  
 15" x 6"  
 FMSI LINING 4504A

Euclid Hardware Kit # E-7969



15" x 5"  
 FMSI LINING 1252

## 15" Single Web Shoes (cont.)

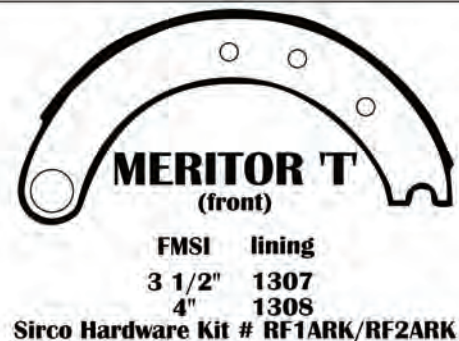

## 15" Single Web Shoes (cont.)



**MERITOR 'Q'**  
(front) (original design)

Meritor #	FMSI	lining
A 3222-Q-1837	4"	1308T

Sirco Hardware Kit # RF3/RF3A



**MERITOR 'Q'**  
(front) (current design)

Meritor #	FMSI	lining
A 3222-F-1982	4"	1308/1308TT

Sirco Hardware Kit # RF3/RF3A



**MERITOR  
WEDGE**  
R.S.A. Stopmaster

FMSI	lining
3 1/2"	1307
4"	1308



**MERITOR  
WEDGE**  
Stopmaster

FMSI	lining
3 1/2"	4562A
5"	4615
6"	4605
7"	4602



**BENDIX  
WEDGE**

FMSI	lining
3"	1290
3 1/2"	4562A
5"	4615
6"	4605
7"	4602



15" X 4"  
**EATON (ES)**  
extended service  
1443TT lining. Web stamping 807686  
Sirco Hardware Kit # EF1

## 15" Double Web Shoes



**BENDIX**  
(Ford Cargo Front)

FMSI	lining
4"	4693

Sirco Hardware Kit #FF1



**DANA HEAVY AXLE**

FMSI	lining
4"	4693

Sirco Hardware Kit #SF1



**MERITOR**  
**15" Q plus**  
extended service shoes (double web)

FMSI	lining	FMSI	lining
4"	4702	7"	4705
5"	4703	8"	4706
6"	4704	8 1/2"	4710

Sirco Hardware Kit #RF5/RF6



**WAGNER**  
(can type rear) 15"

FMSI	lining
6"	4594
7"	4595

Batco Hardware Kit #08-108400

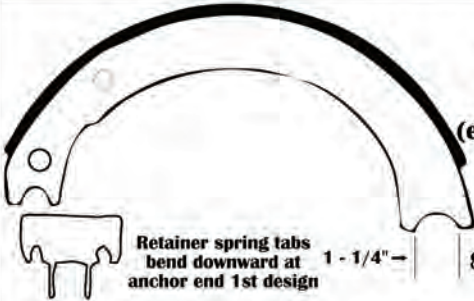

**EATON**  
**ES BRAKE**  
(extended service)

FMSI	lining
6"	4716/ES3
7"	4723
8 1/2"	4717/ES4
10"	4724

Retainer spring tabs bend downward at 1 - 1/4" ← anchor end 1st design



5812 Curlew Drive  
Norfolk, VA 23502

Tele: 757.466.1308

Fax: 757.466.8313

Toll-Free: 800.552.2005

[www.eastcoastbrake.com](http://www.eastcoastbrake.com)

## 16" & 16 1/4" Diameter Shoes

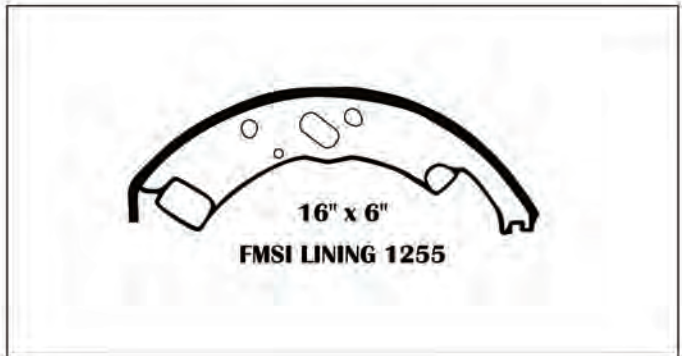
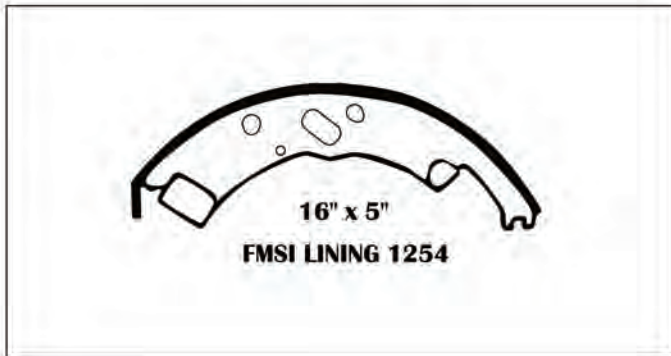

## 16 1/2" Diameter Shoes

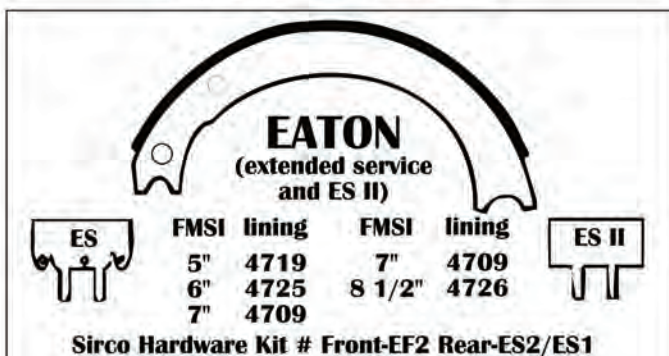
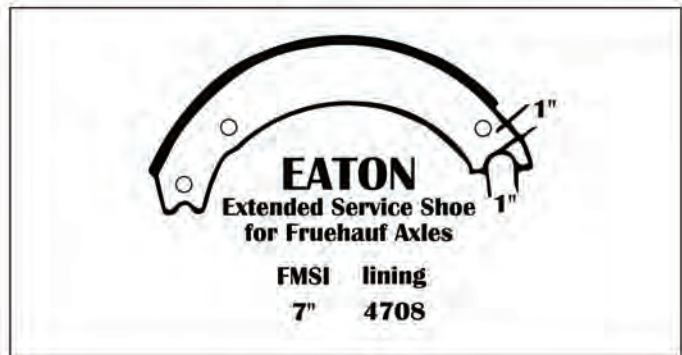
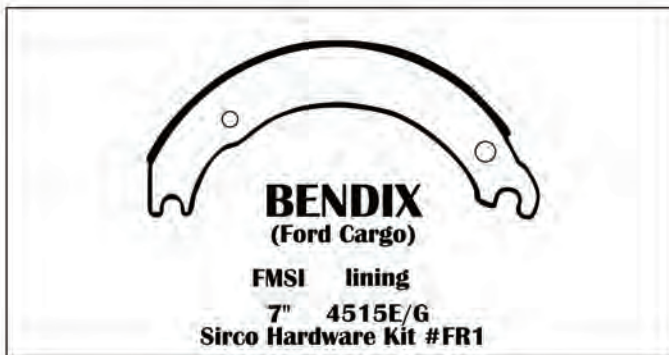



## 16 1/2" Diameter Shoes (cont.)

**RETAINER HOLE**  
**FRUEHAUF XEM 2nd Design**

FMSI	lining
7"	4515E/G
8 1/2"	4551B
8 1/2"	4551B

\*Offset Webs  
Sirco Hardware Kit #XK2

**X3**  
**FRUEHAUF XEM 3rd Design**

FMSI	lining	FMSI	lining
7"	4515	8 1/2"	4551B
7"	4515E/G	8 1/2"	4551B

LEFT HAND RIGHT HAND  
PLACEMENT OF OFFSET WEBS

Sirco Hardware Kit #XK3

**SF**  
**FRUEHAUF 'Q'**

Meritor design for Fruehauf application. Designed for ESF or F5.

Not interchangeable with standard 'Q'

FMSI	lining
7"	4515E/G

Sirco Hardware Kit #QK1HD

**MERITOR 'P' STYLE**  
(Brushed anchor)

FMSI	lining	Sirco Hardware Kit
7"	4515	#TK7
7"	4625B	#MK1HD

**T**  
**MERITOR 'P' STYLE**

FMSI	lining
6"	4514G
7"	4515
7"	4515E/G
8"	4644A
8"	4644A
8"	4644A
8 1/2"	4551B
10"	4552
10"	4514G/4549C

\*offset webs  
#offset pin location for mack  
Sirco Hardware Kit #TK1

FMSI	lining	FMSI	lining
4"	4549C	5"	4524B
5"	4524B	6"	4514G

**ST**  
**QUICK CHANGE**  
(Equivalent to 'Q' Style)

Features improved anchor slot design

FMSI	lining	FMSI	lining
6"	4514G	6"	4514G
7"	4515	7"	4515
7"	4515E/G	7"	4515E/G
8"	4644A	8"	4644A
8"	4644A	8"	4644A
8"	4644A	8"	4644A
8 1/2"	4551B	8 1/2"	4551B
10"	4552	10"	4552
10"	4514G/4549C	10"	4514G/4549C

\*offset webs  
#offset pin location for mack  
Sirco Hardware Kit #QK1HD

FMSI	lining	FMSI	lining
4"	4549C	5"	4524B
5"	4524B	6"	4514G

**XT**  
**MERITOR Q Plus Brake**

no bulge

FMSI	lining	FMSI	lining
5"	4720/MF2	7"	4707/QK1HD
6"	4715/MF2	8"	4718/QK1HD
6"	4715A	8 1/2"	4711/QK1HD

Requires ext. life s-cam